

PRODUCT SPECIFICATION

Part Number
PDC302SM-CxDB01

Details

- 0.30" Surface Mount LED Display
- 2 Digit, 7 Segment
- Common Anode or Common Cathode
- InGaN Chip Material
- Emitting Color: Blue

Features

- Low power consumption
- RoHS Compliant
- Gray Face, White Segments or Black Face, White Segments
- Easy mounting on PCB or socket

Mechanical Dimensions

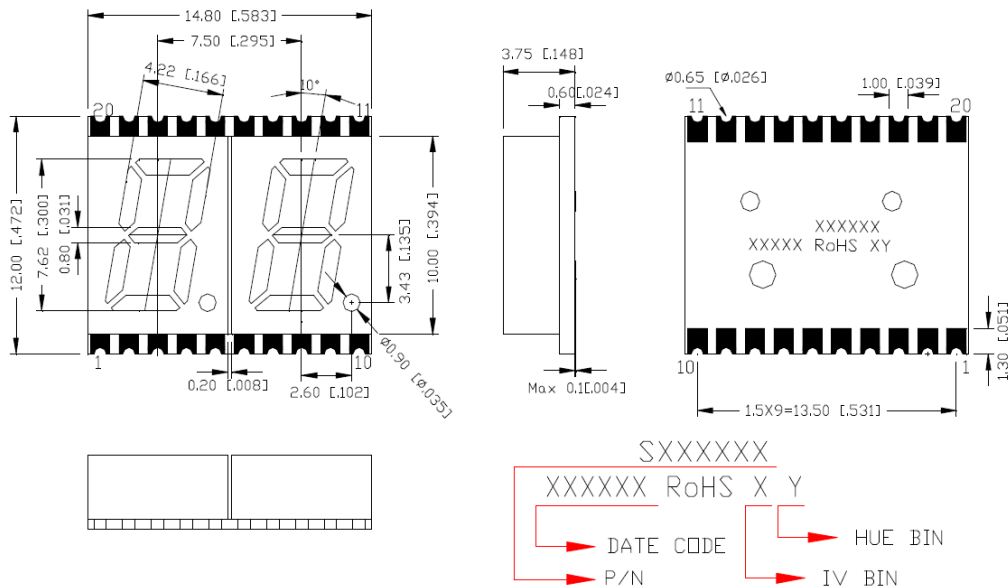

Notes:

1. Dimensions in millimeters [inch], and tolerance is ± 0.25 [0.010] unless otherwise noted.
2. Bending \leq Length*1%
3. All pins are $\varnothing 0.51$ [0.020] \pm 0.1 [0.004]
4. Specifications subject to change without notice





Device Selection Guide

Model Number		Chip		Note
Common Anode	Common Cathode	Material	Emitting Color	
PDC302SM-CADB01	PDC302SM-CCDB01	InGaN	Blue	Add “-BW” to end of part number for Black Face, White Segment version

Absolute Maximum Ratings at Ta=25 °C

Parameter	Symbol	Rating	Unit
Power Dissipation per Dice	PAD	114	mW
Derating Liner from 25°C per Dice	--	0.4	mA/°C
Continuous Forward Current Per Dice	IAF	30	mA
Peak Current Per Dice (duty cycle 1/10, 1KHz)	IPF	100	mA
Reverse Voltage Per Dice	VR	5	V
Electrostatic Discharge (HBM)	ESD	1000	V
Operating Temperature	Topr	-40~+105	°C
Storage Temperature	Tstg	-40~+105	°C

Solder Conditions: 1/16 inch below seating plane for 3 -5 seconds at 260°C.

Electrical and Optical Characteristics at Ta=25 °C

Parameter	Symbol	Min.	Typ.	Max.	Unit	Condition
Forward Voltage Per Segment	VF	--	3.2	3.8	V	IF=20mA
Luminous Intensity Per Segment	Iv	--	7	--	mcd	IF=10mA
Dominant Wavelength	λd	--	465	--	nm	IF=20mA
Reverse Current	IR	--	--	50	μA	VR=5V
Luminous Intensity Matching Ratio	Iv-m	--	--	2:1	--	IF=10mA

Luminous General I_v Bin Grade (I_F=10mA)

A	B	C	D	E	F	G	H	J	K	L	M
0.155	0.249	0.399	0.640	1.025	1.641	2.627	4.204	6.727	10.764	17.224	27.559
0.248	0.398	0.639	1.024	1.640	2.626	4.203	6.726	10.763	17.223	27.558	44.095
N	P	Q	R	S	T	U	V	W	X	Y	1
44.096	70.555	112.889	180.623	288.997	462.397	739.836	1183.738	1893.982	3030.372	4848.597	7757.756
70.554	112.888	180.622	288.996	462.396	739.835	1183.737	1893.981	3030.371	4848.596	7757.755	12412.409
2	3	4	5	6	7	8	9				
12412.410	19859.858	31775.773	50841.238	81345.982	130153.573	208245.718	333193.149				
19859.857	31775.772	50841.237	81345.981	130153.572	208245.717	333193.148	533109.039				

Remark: Unit=mcd

*Tolerance: ±20%

Color Rank Limits (I_F=20mA)

2	3	4	5	6
456.0	459.0	462.0	465.0	468.0
459.0	462.0	465.0	468.0	471.0

Remark: Unit=nm

*Tolerance: ±1

All Light-On Segments Feature & Pad Position

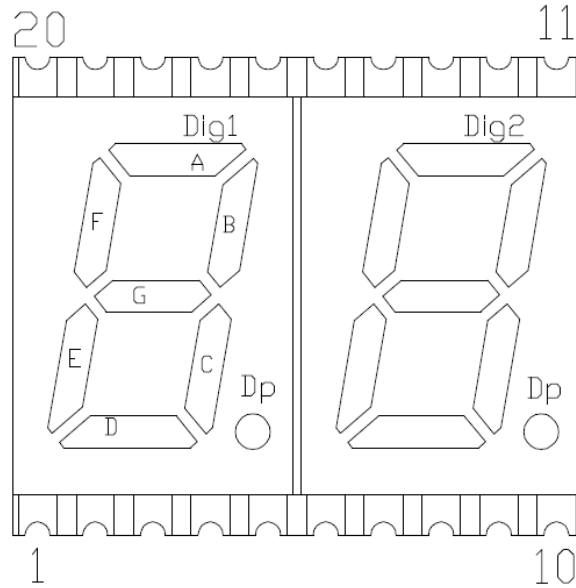

Internal Circuit Diagram

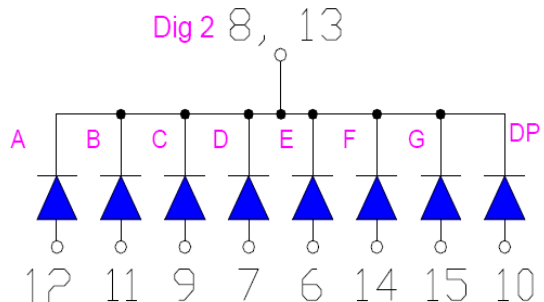
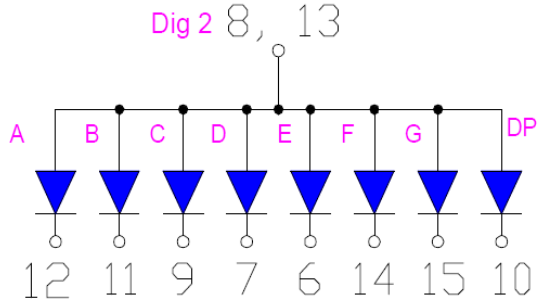
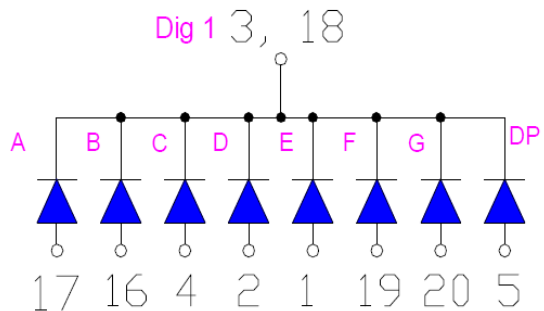
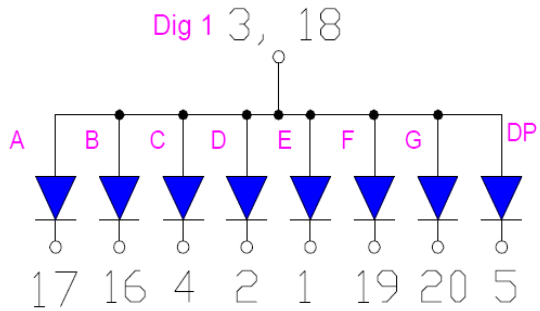

Common Anode

Common Cathode

Typical Electrical / Optical Characteristic Curves

- (Ta = 25°C Unless Otherwise Noted)

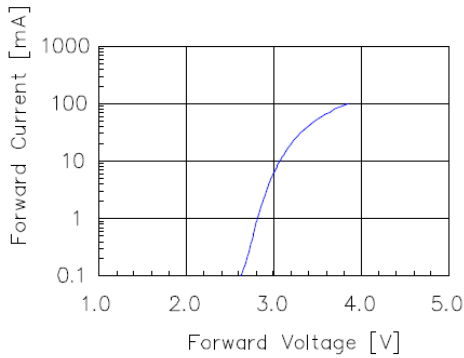

Fig 1. Forward Current vs. Forward Voltage

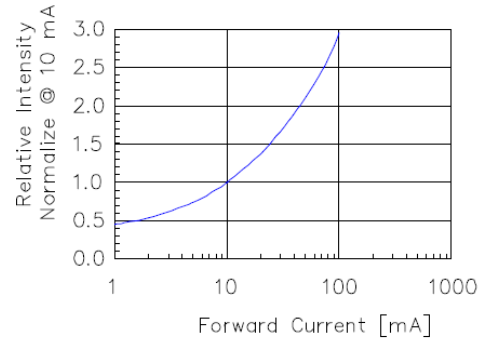

Fig 2. Relative Intensity vs. Forward Current

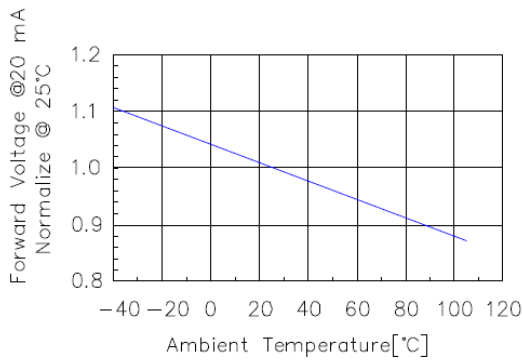

Fig 3. Forward Voltage vs. Temperature

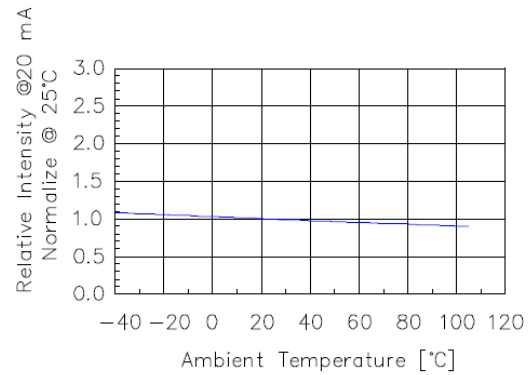

Fig 4. Relative Intensity vs. Temperature

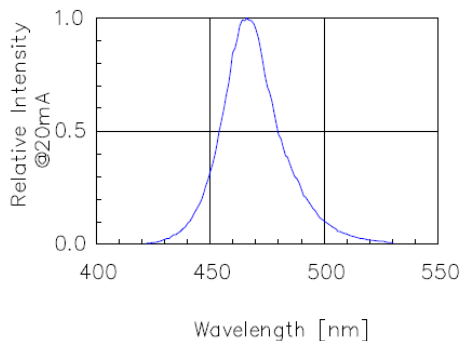
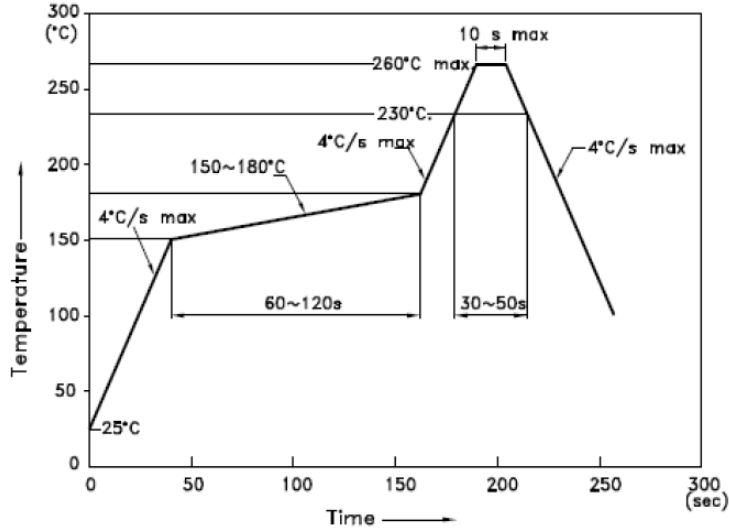

Fig 5. Relative Intensity vs. Wavelength

SMT Reflow Soldering Instructions



NOTES:

1. We recommend the reflow temperature 245°C(+/-5°C). The maximum soldering temperature should be limited to 260°C.
2. Don't cause stress to the epoxy resin while it is exposed to high temperature.
3. Number of reflow process shall be 2 times or less.

Soldering Pad Size

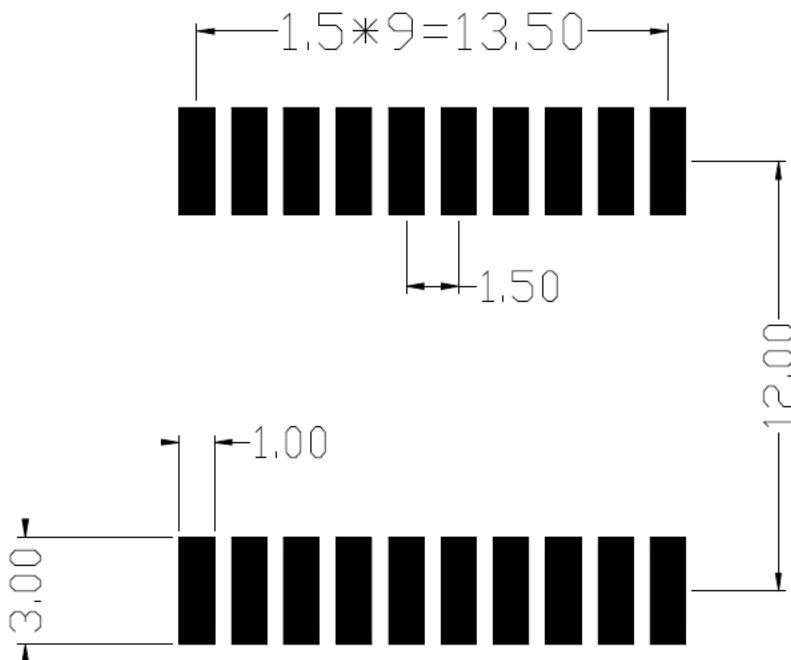

Reel & Packing Dimensions

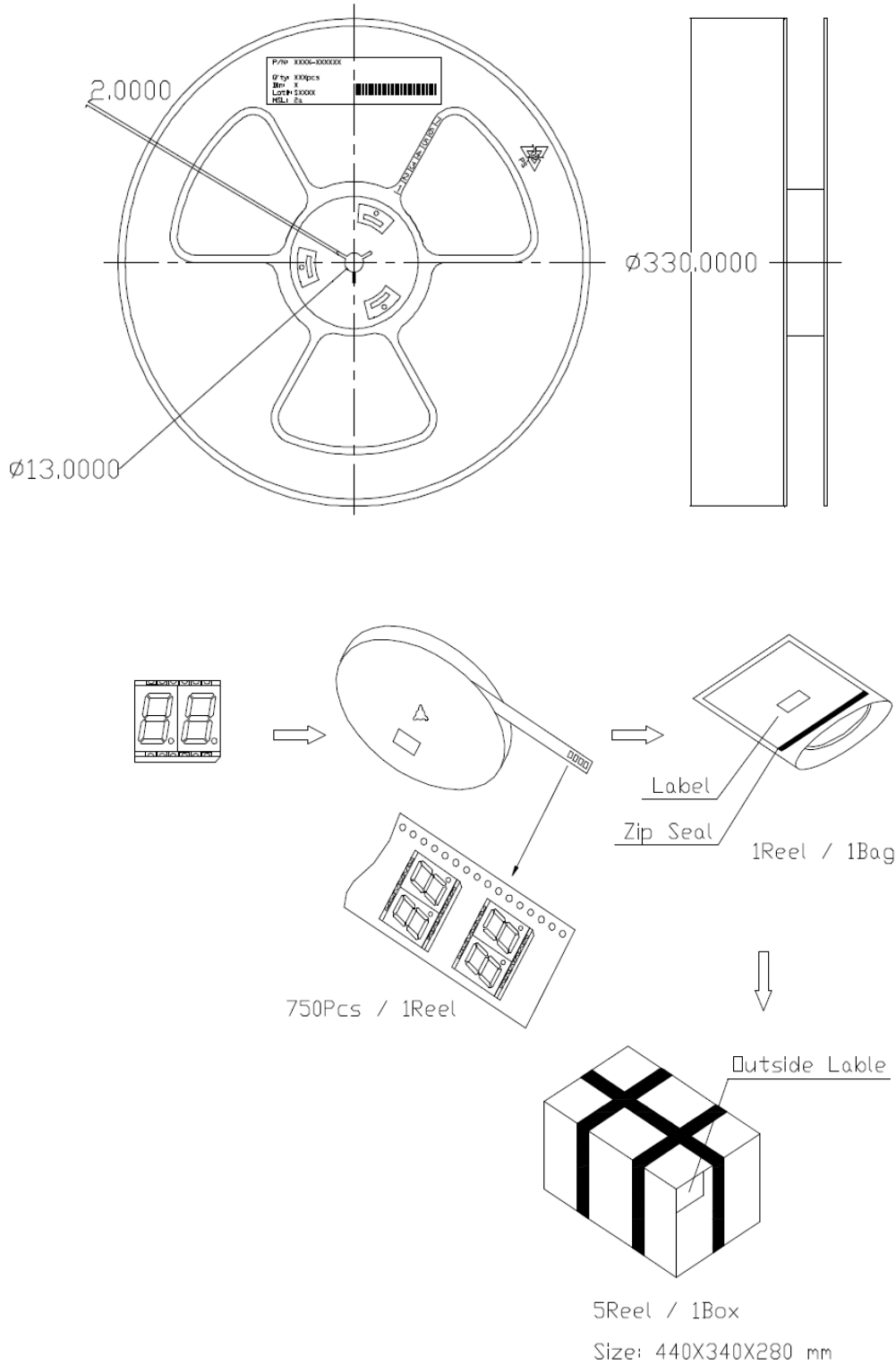



PDC302SM-CxDB01 Customer Approval Signatures	Approved Part Number	Approved By	Notes/Remarks

Record Of Revisions			
Rev.	Comments	Page	Date
0	Released Spec	--	06/13/17